

F07

**TERMOSTATI E MANICOTTI
THERMOSTATS AND SLEEVES**

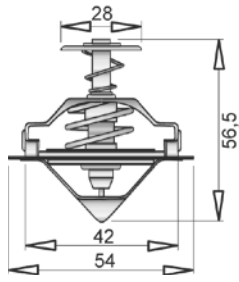

TM001 76,5 °C NISSAN SD22-25

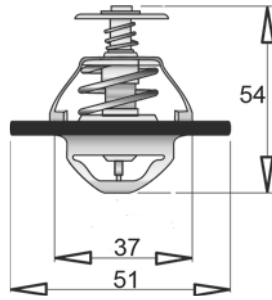

TM002 77 °C TOYOTA 5K-4Y

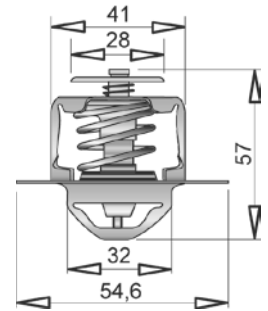

TM003 82 °C KOMATSU 4D95

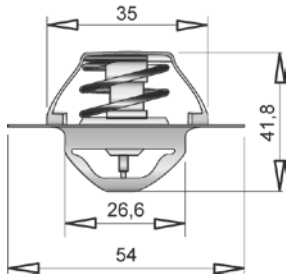

TM004 77 °C

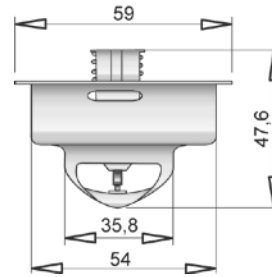

TM005 76,5 °C MITS. S4E-4DQ5-4DQ7 S6E

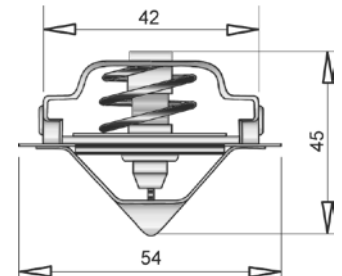

TM006 82 °C MITSUBISHI 4G33

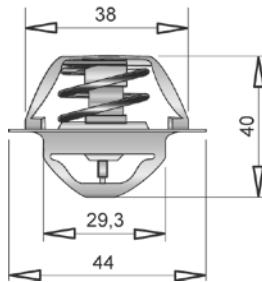

TM007

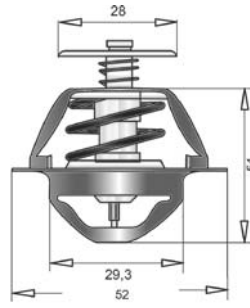

TM008 TOYOTA 1Z - 1DZ

ECCENTRICO - ECCENTRIC

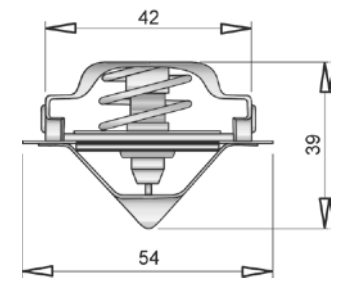

TM009 82 °C ISUZU C240
TOYOTA

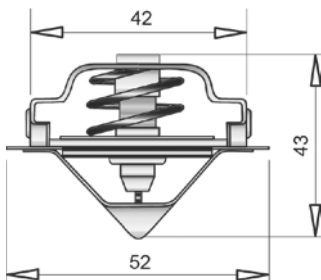

TM020 77/82 °C ISUZU C221

ECCENTRICO - ECCENTRIC

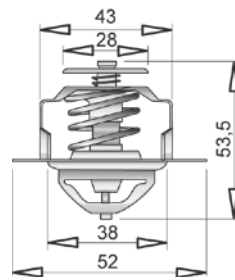

TM011 77 °C MITS. S4S-S6S-S4Q2

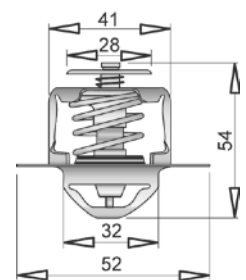

TM012 82 °C TOYOTA 1DZ

F07

**TERMOSTATI E MANICOTTI
THERMOSTATS AND SLEEVES**

ECCENTRICO - ECCENTRIC

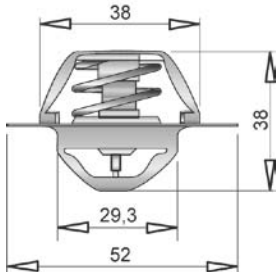

TM013 82 °C

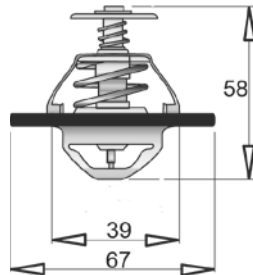

TM014 81 °C PEUGEOT

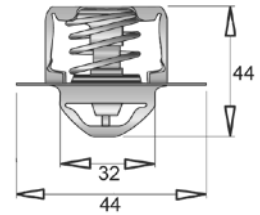

TM015 71 °C KUBOTA

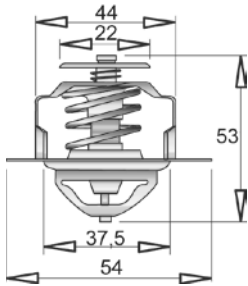

TM016 76,5 °C CESAB-KUBOTA

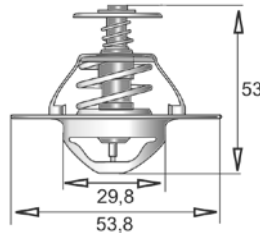

TM017 82° NISSAN TD27 SD22

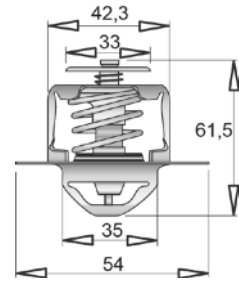

TM018 82 °C MAZDA XA

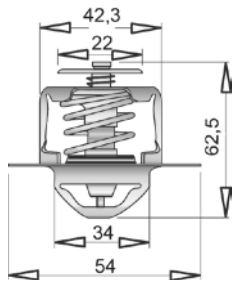

TM019 82 °C ISUZU 4JB1

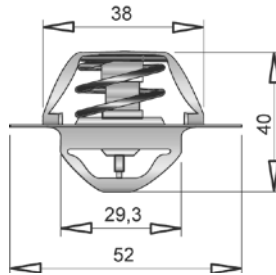

TM010 82 °C TOYOTA 2J

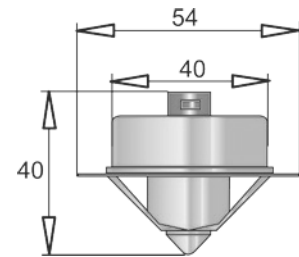

TM021 82 °C CONTINENTAL TM27

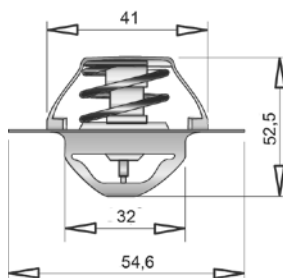

TM022 82 °C KOMATSU 4D95S

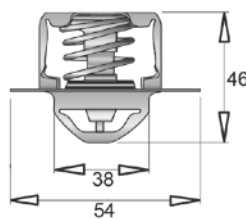

TM023 82 °C NISSAN A15

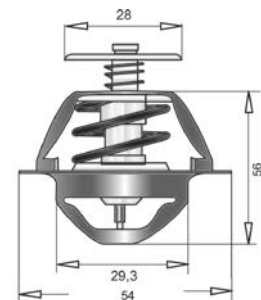

TM025 76 °C NISSAN H25 ISUZU 4JG2

F07

**TERMOSTATI E MANICOTTI
THERMOSTATS AND SLEEVES**

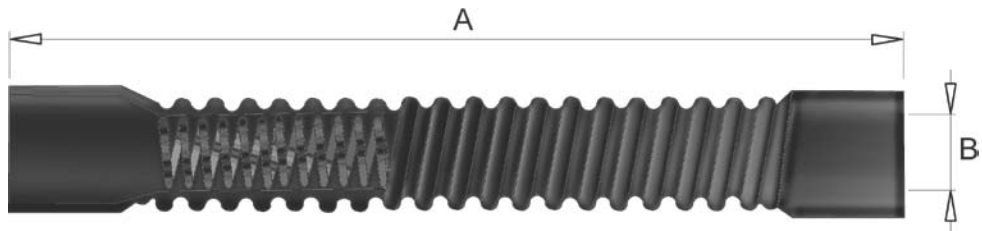
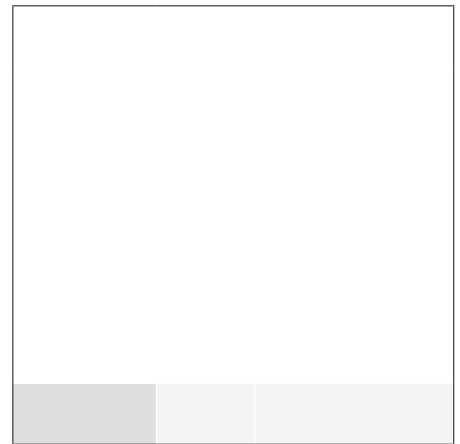
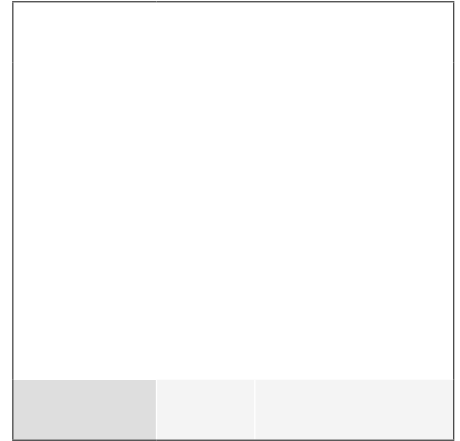
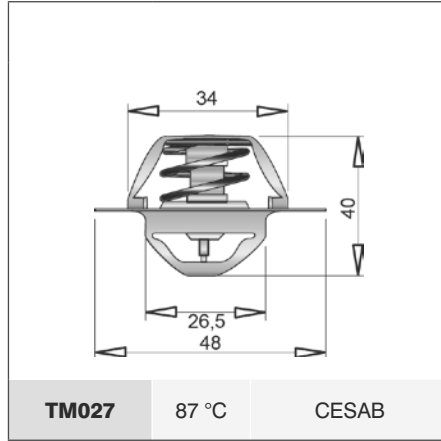
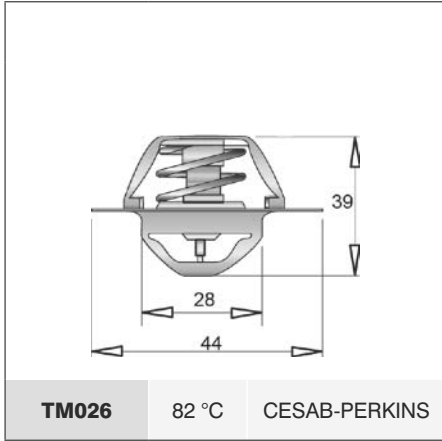

**MANICOTTI RADIATORE CON SPINALE IN ACCIAIO
RADIATOR HOSE WITH STEEL CORE**

Codice Code	A	B	Applicazione Used for
2923	575	32	CESAB - KUBOTA
7923	325	32	CESAB - KUBOTA
3923	285	35	CESAB
4923	400	35	CESAB
5923	450	35	CESAB
6924	500	34/38	-
6923	600	34/38	CESAB
7214	450	32/38	CESAB
7215	350	34/38	CESAB
BK11337	337	45	SIBICAR-BALKANCAR
BK10346	438	38	SIBICAR-BALKANCAR
6813	433	38	CESAB